

413.714.00
Kit reparación tapa cilindro
línea DBT

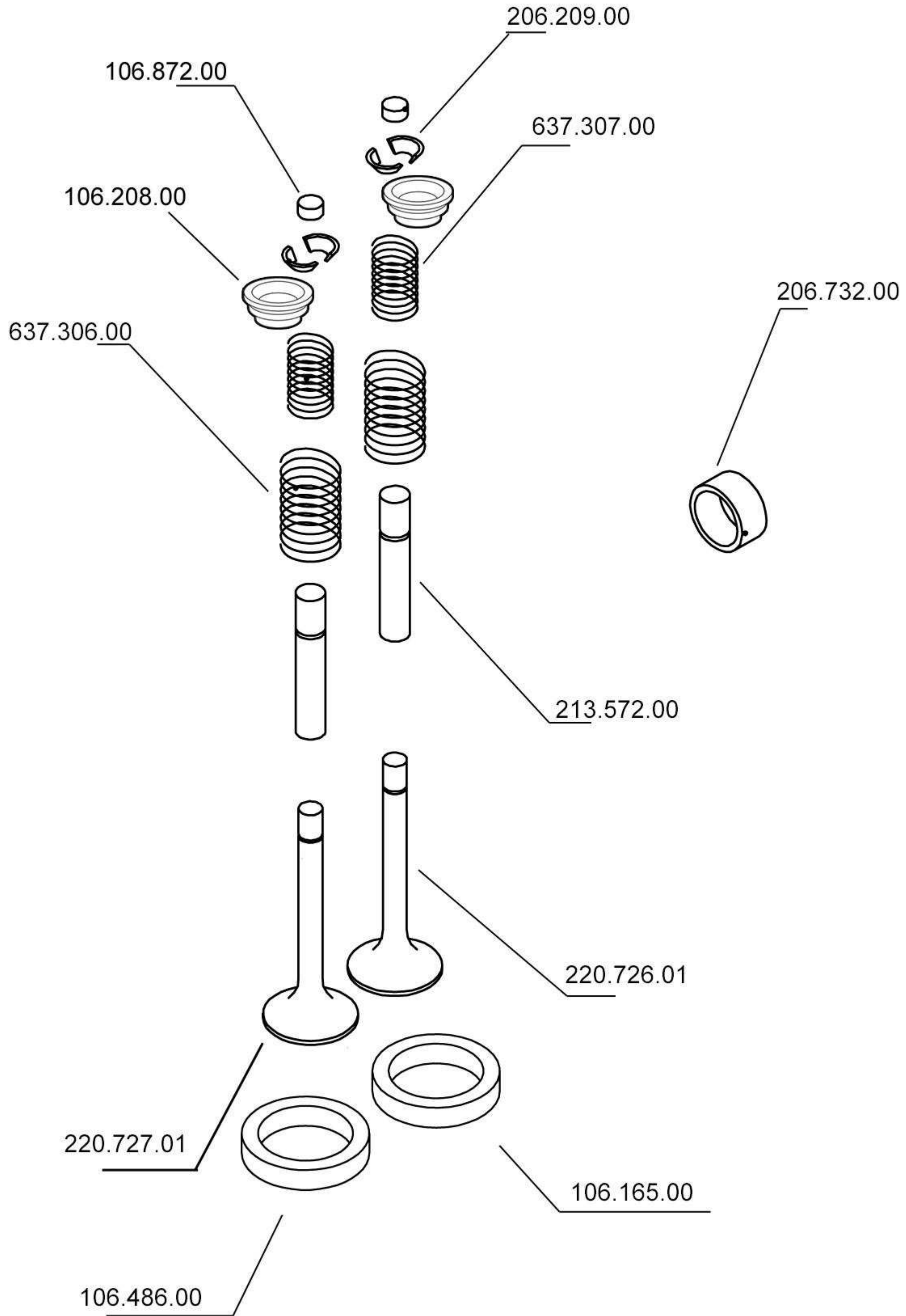

**413.418-00 Kit juntas
tapa cilindro línea DBT monocilíndrica**

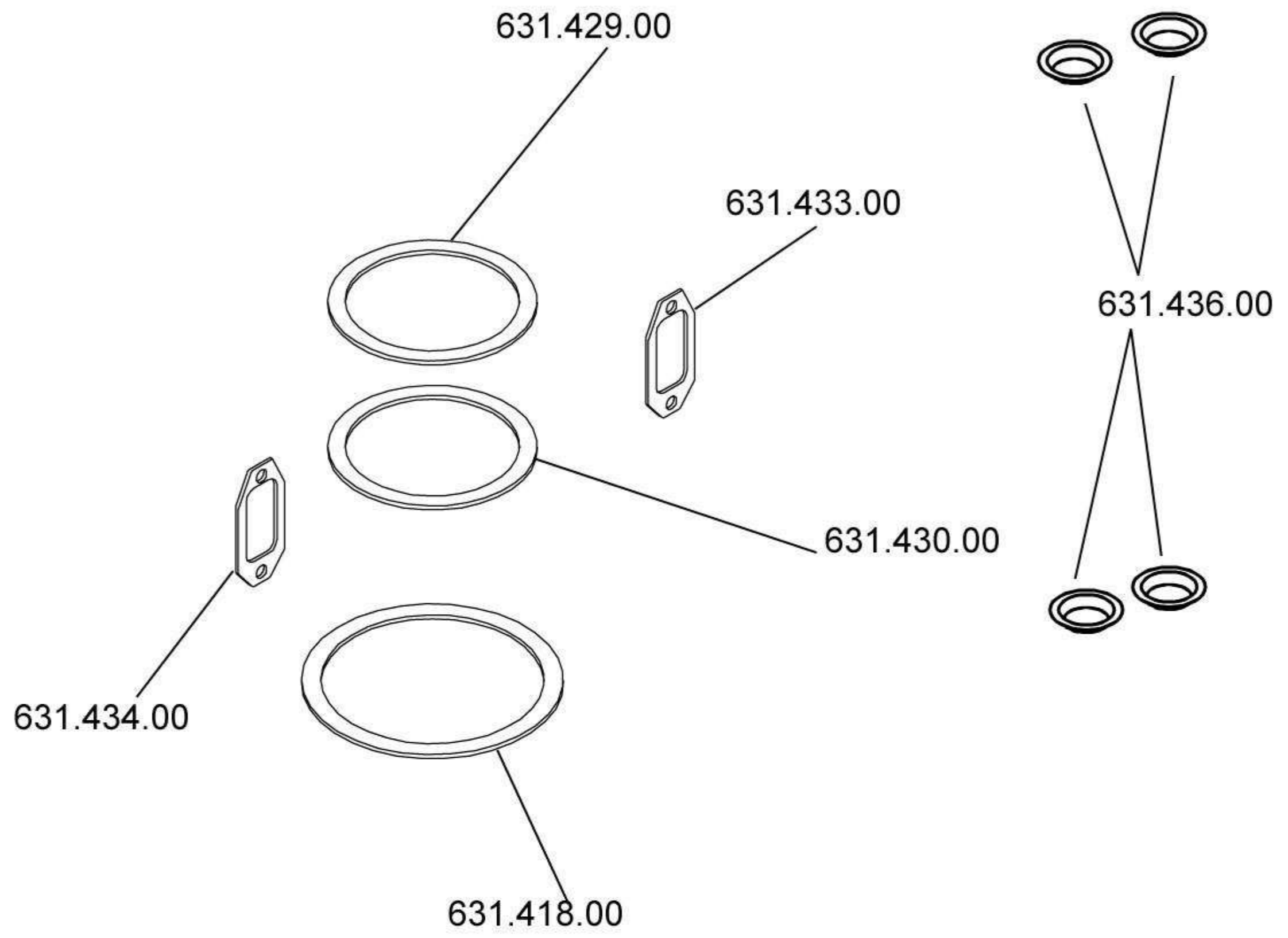

414.139.00
Kit reparaciones inyector
línea DBT

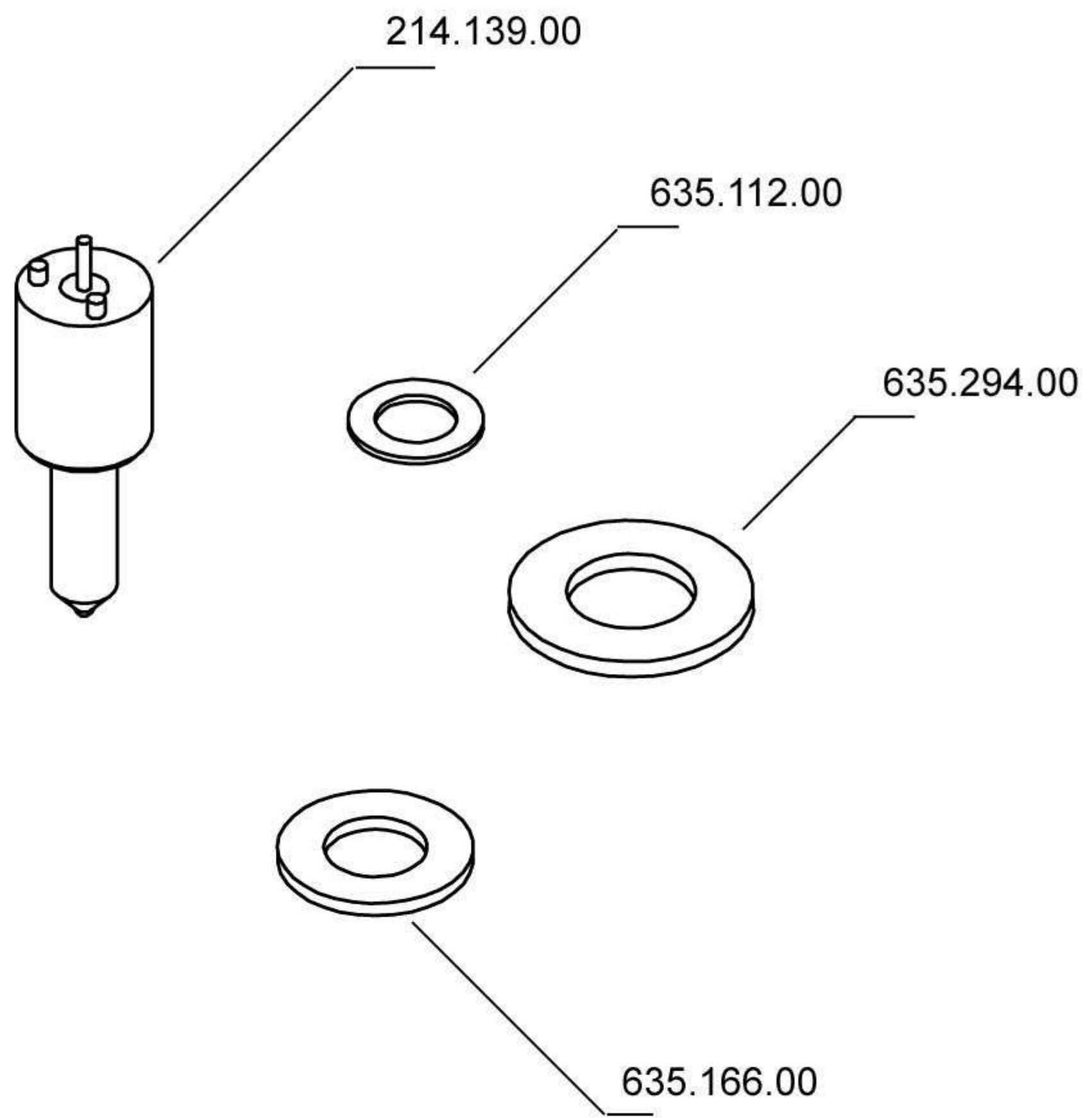

414.944.01
Kit reparaciones regulador
Línea DBT

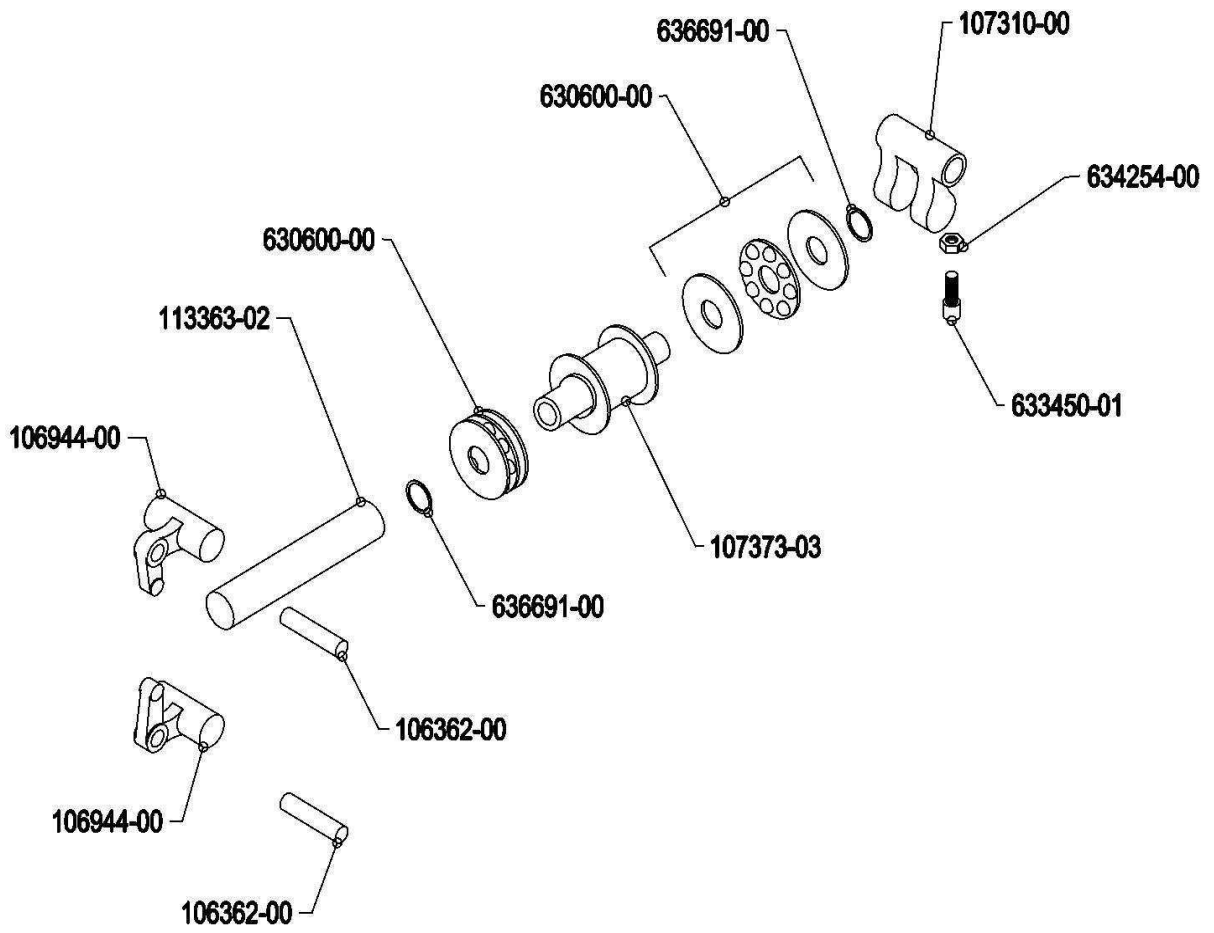

417.701.00
Kit reparaciones
cilindro - pistón
motores 11,5 DBT / 24 DBT

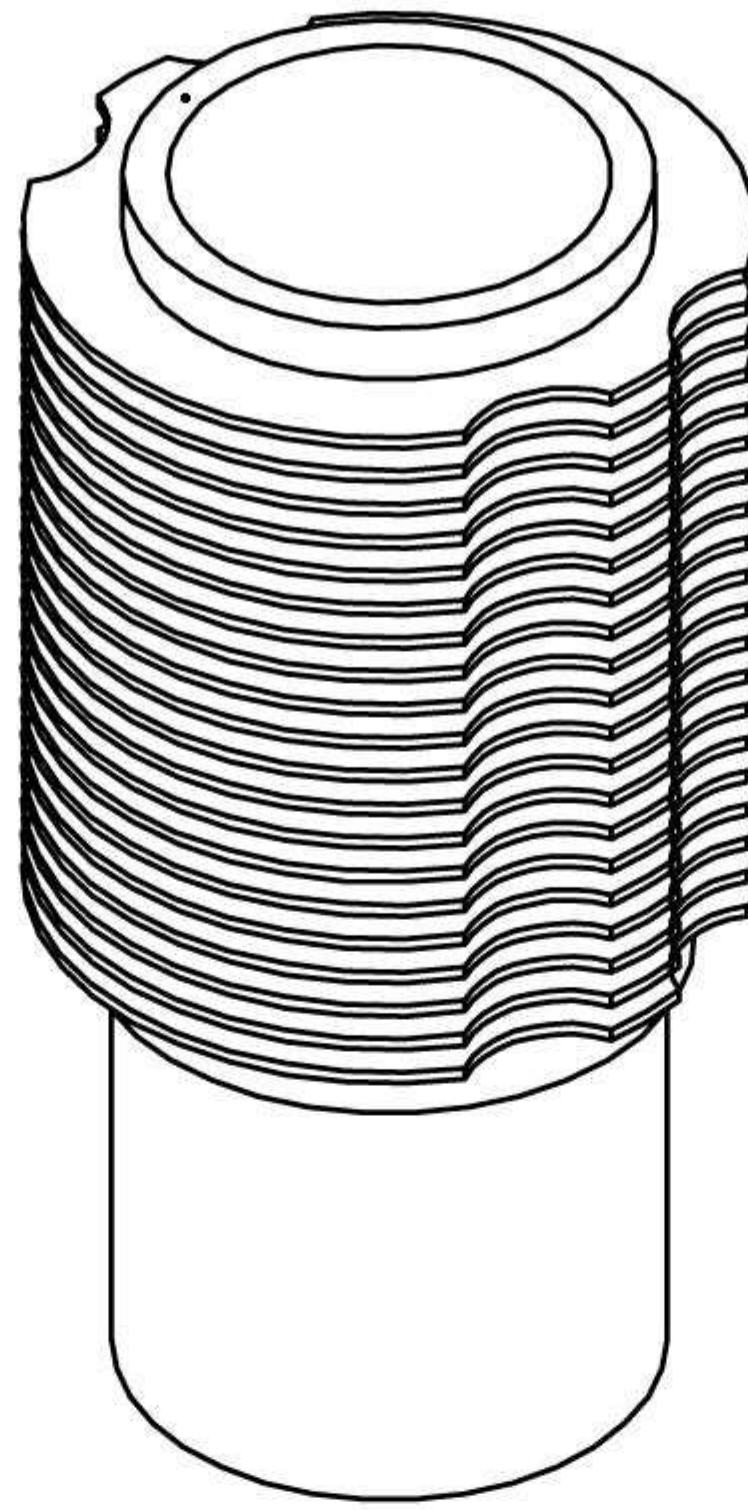

117.700.00

209.787.00 - Std.
209.818.01 - .020

209.785.00

636.674.00

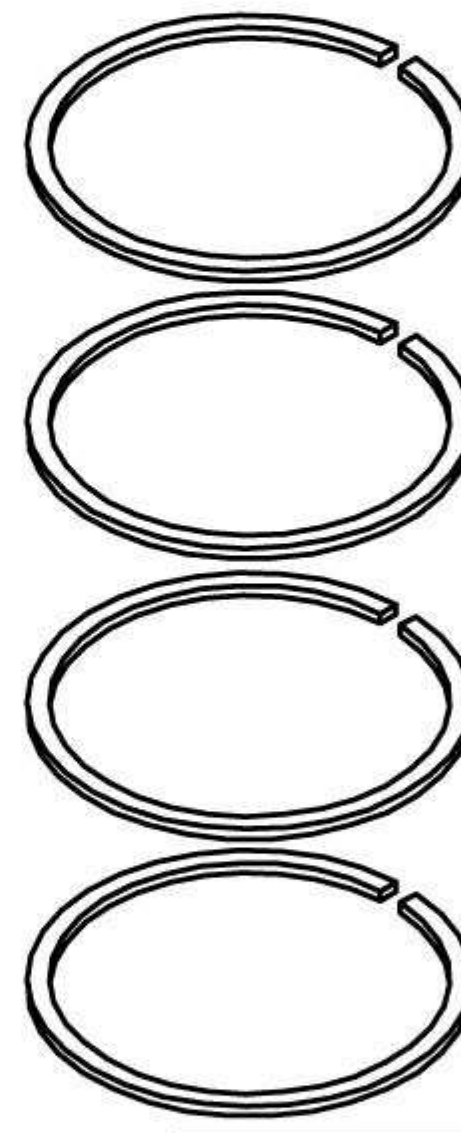
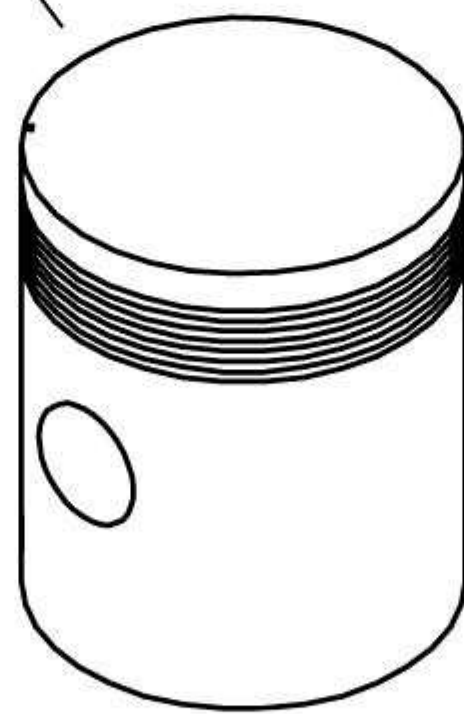
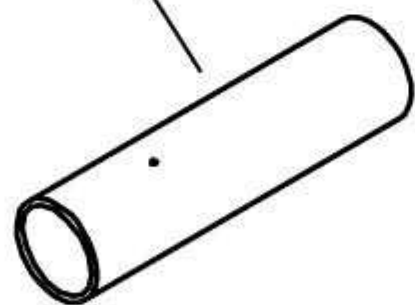

409.787.00 - Std.
409.798.01 - .020

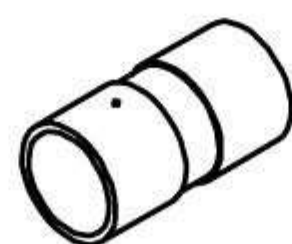

209.783.00

417.705.00 - Std.
417.706.00 - .020

420.007-00
Kit reparaciones bomba inyectora
linea DBT

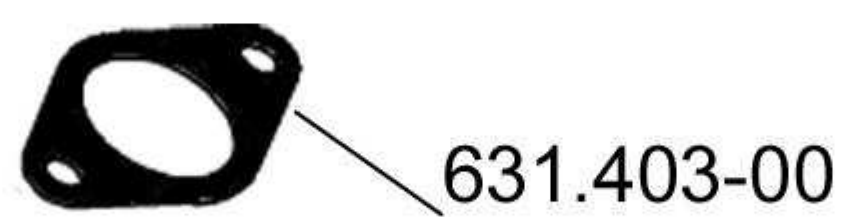
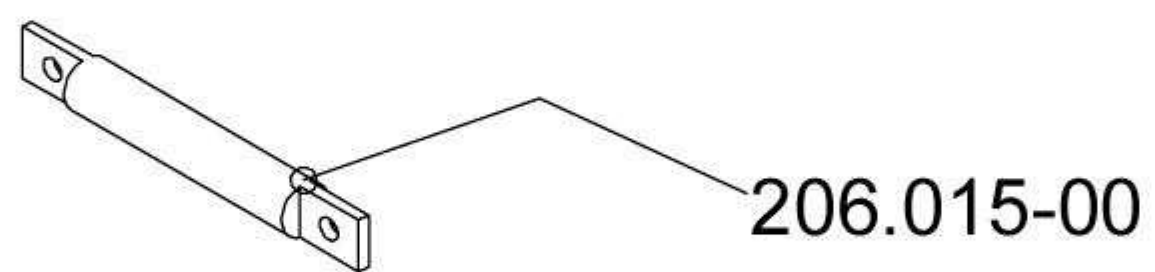
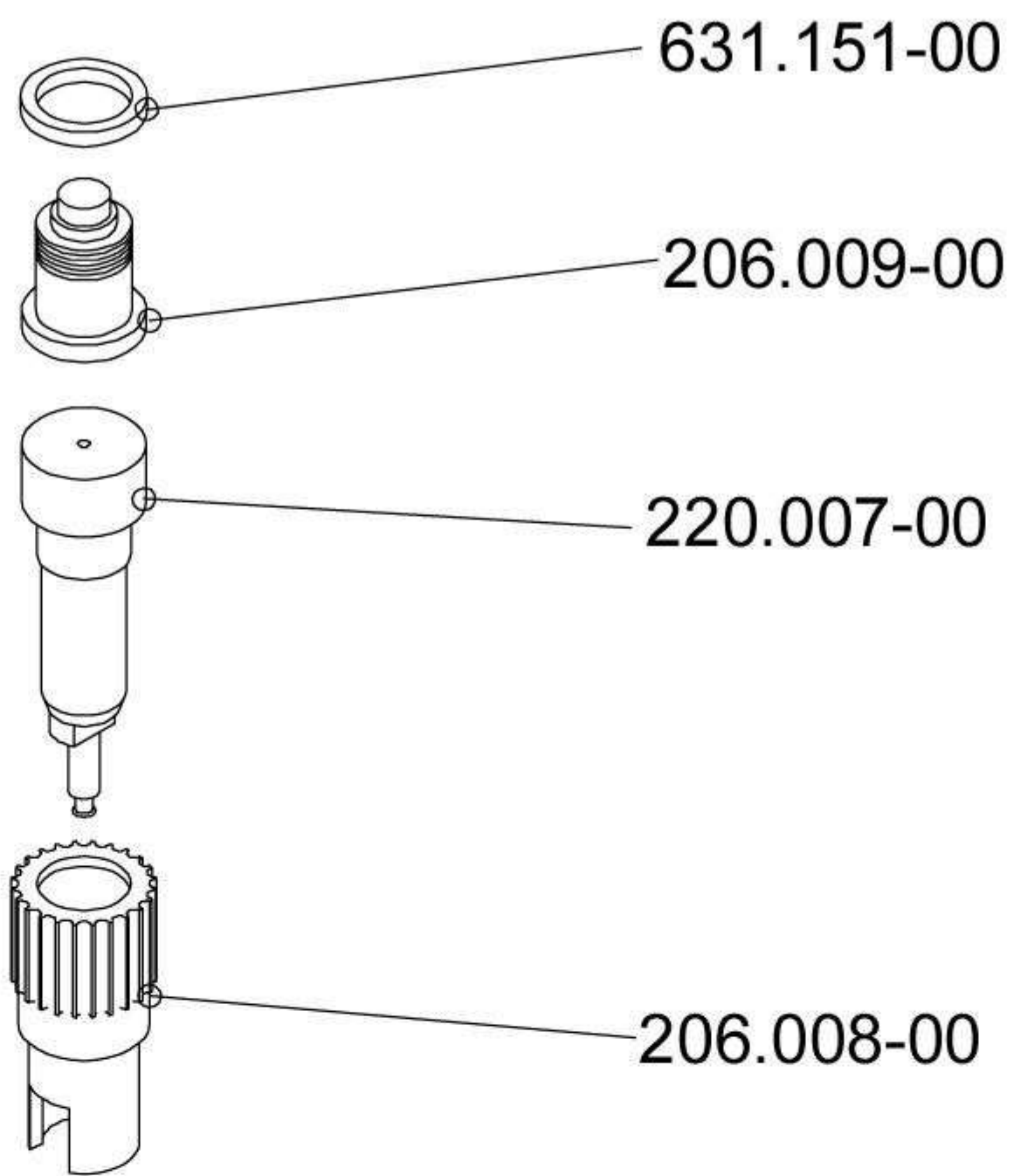

**420.418-00 Kit junstas
tapa cilindro línea DBT bicilíndrica**

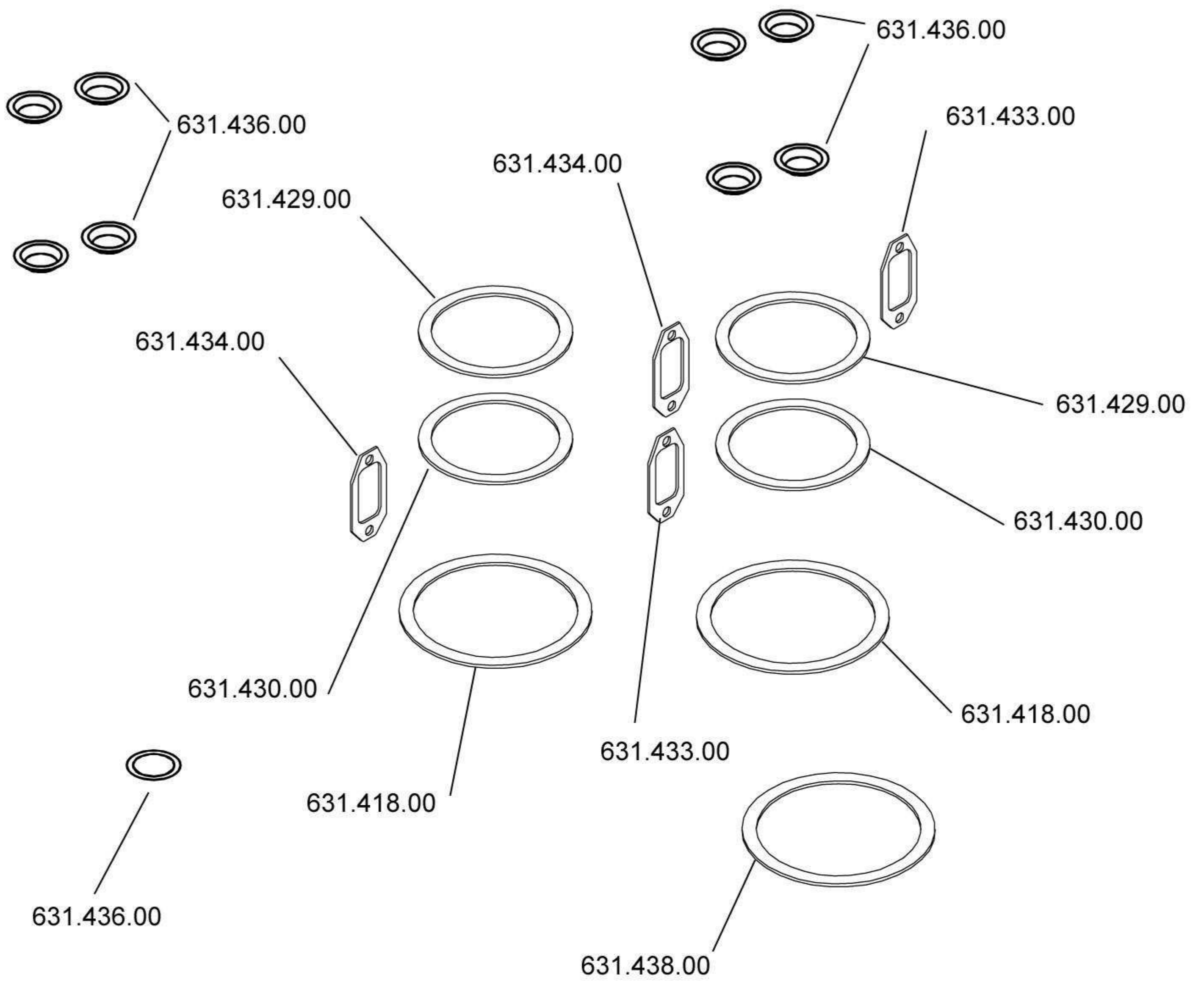

420.701.00
Kit reparaciones
cilindro - pistón
motores 13 DBT / 27 DBT

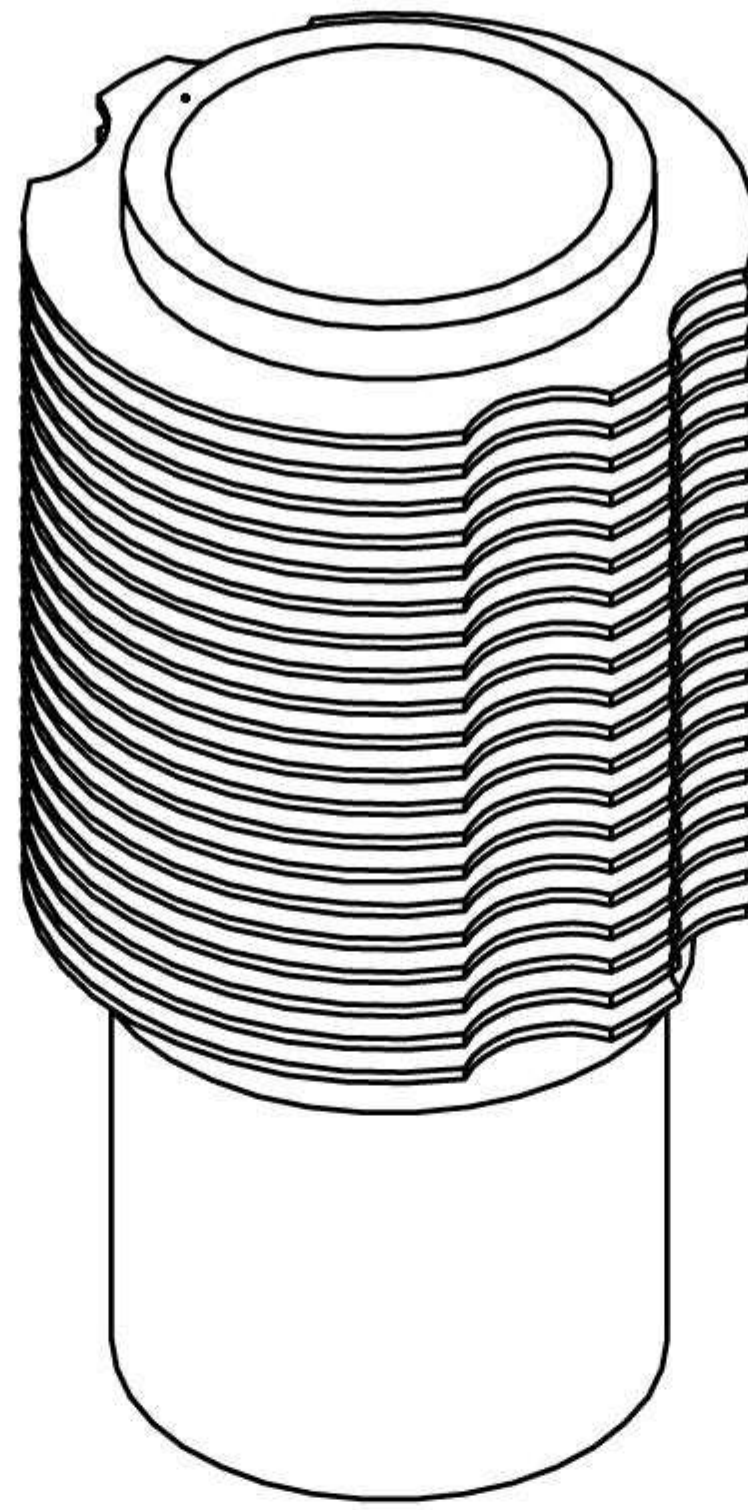

120.700.00

220.787.00 - Std.
220.818.00 - .020

220.785.00

636.674.00

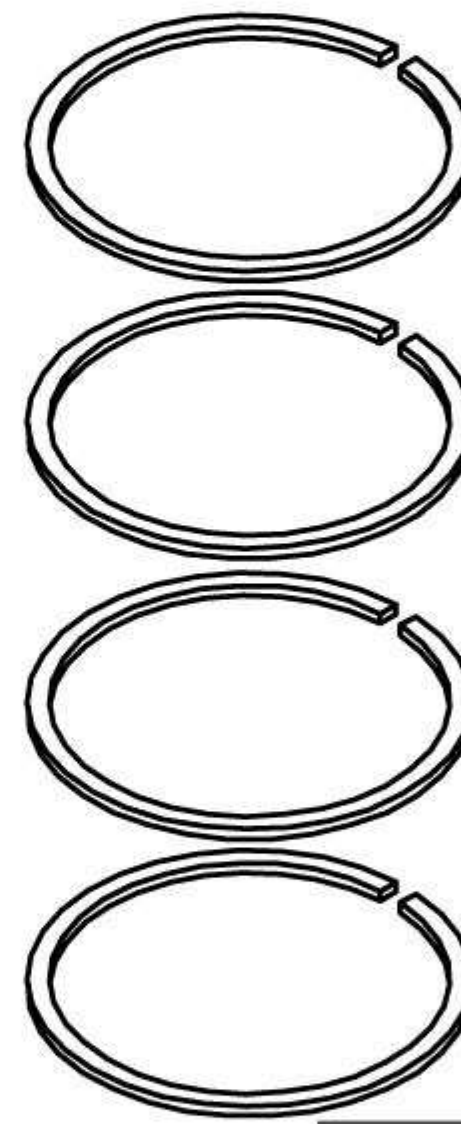
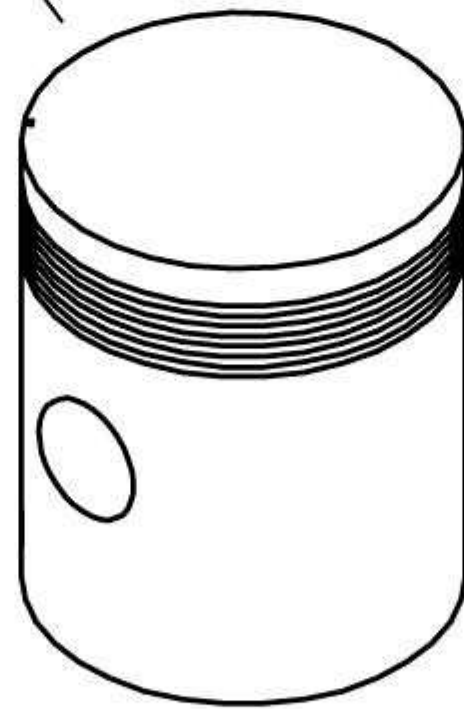
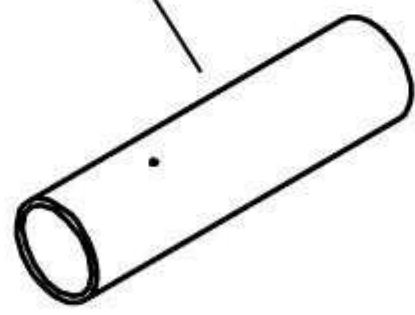

420.787.00 - Std.
420.818.00 - .020

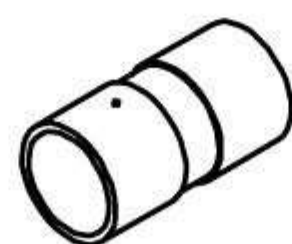

209.783.00

420.705.00 - Std.
420.706.00 - .020

513.100.00
Kit mantenimiento
línea DBT
monocilíndrica

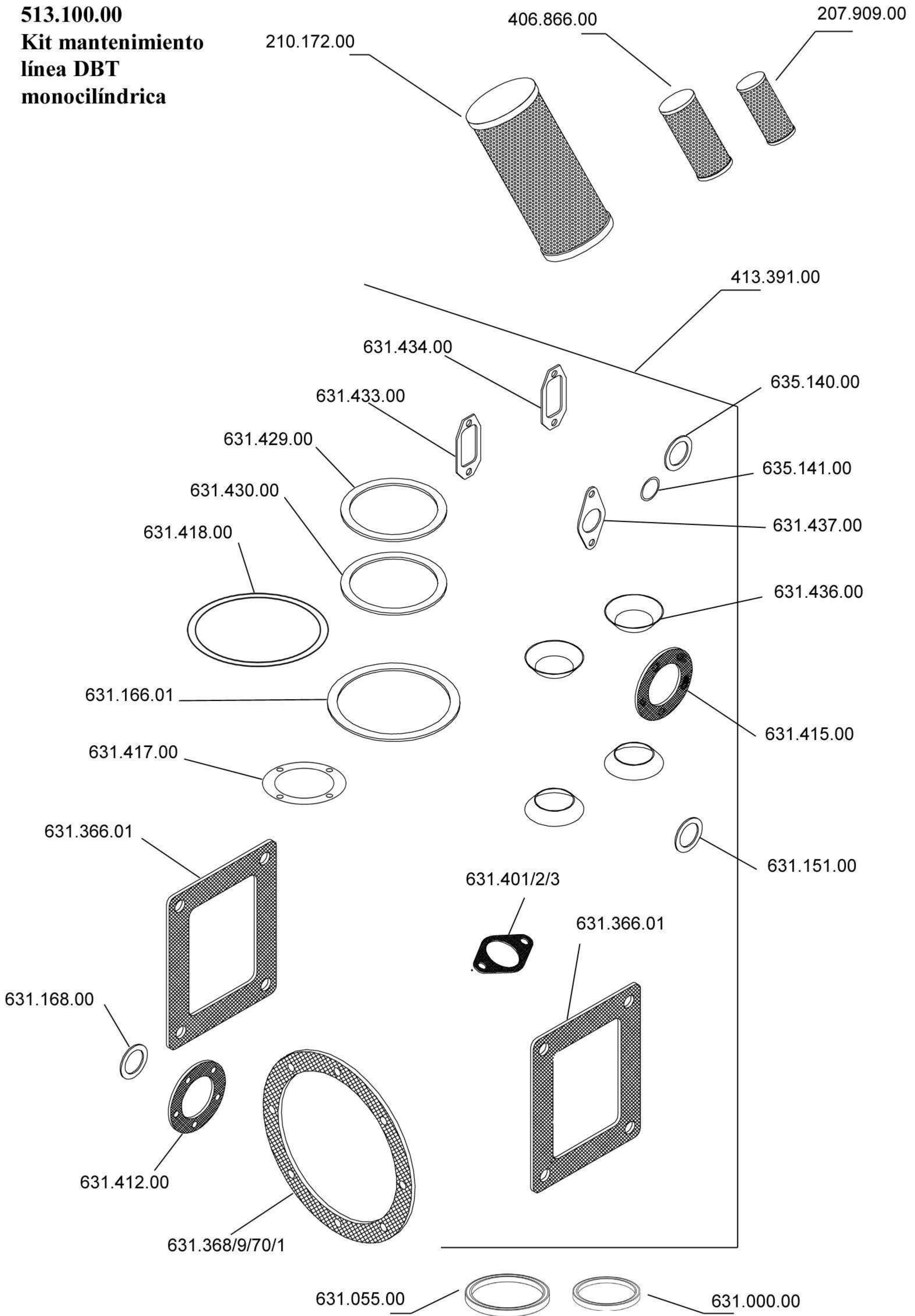

511.100.00

**Kit mantenimiento
línea DBT
monocilíndrica**

210.172.00

406.866.00

207.909.00

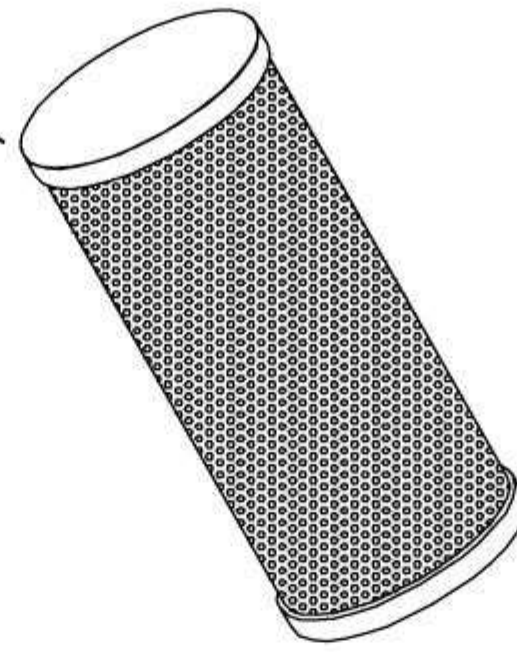

413.391.00

631.434.00

635.140.00

631.433.00

631.429.00

635.141.00

631.430.00

631.437.00

631.418.00

631.436.00

631.166.01

631.415.00

631.417.00

631.151.00

631.366.01

631.401/2/3

631.366.01

631.168.00

631.412.00

631.368/9/70/1

631.055.00

631.000.00

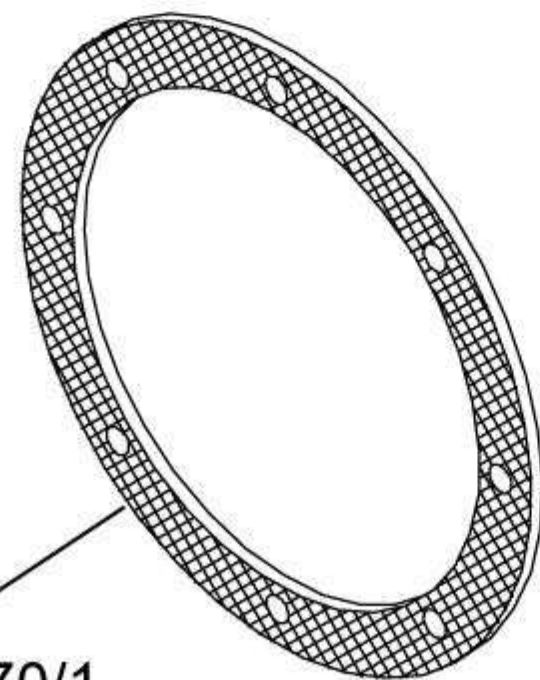
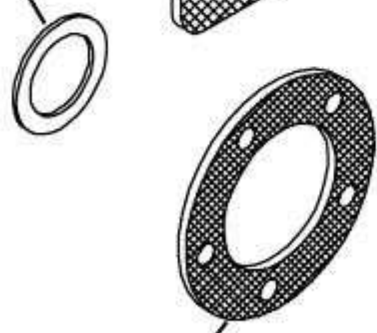
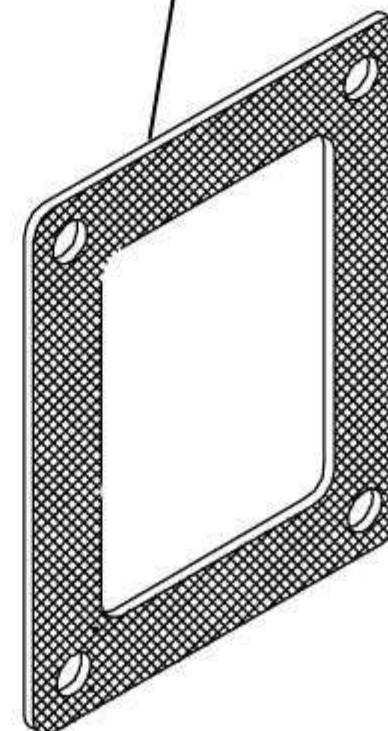
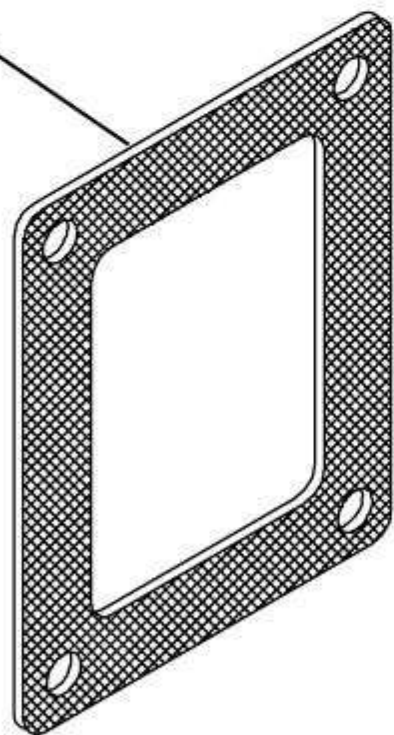

524.100.00

Kit mantenimiento línea DBT
bicilíndrica

